

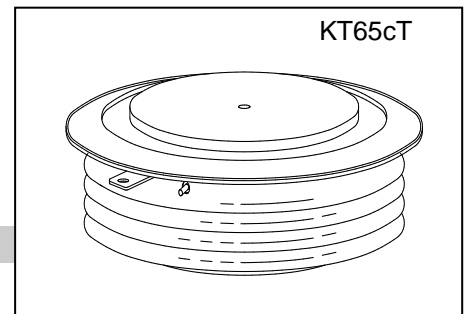

HIGH POWER THYRISTOR FOR INVERTER APPLICATION

Features:

- . All Diffused Structure
- . Amplifying Gate Configuration
- . Blocking capability up to 1400 volts
- . High dv/dt Capability
- . Pressure Assembled Device



ELECTRICAL CHARACTERISTICS AND RATINGS

Blocking-Off State

Device Type	V _{RRM} (1)	V _{DRM} (1)	V _{RSM} (1)
KK1800/12	1200	1200	1400
KK1800/14	1400	1400	1600

V_{RRM} = Repetitive peak reverse voltage
V_{DRM} = Repetitive peak off state voltage
V_{RSM} = Non Repetitive peak reverse voltage(2)

Repetitive peak reverse leakage and off state leakage	I _{RRM} /I _{DRM}	2 mA 20 mA (3)
Critical rate of voltage rise	dv/dt (4)	1000 V/sec (min)

Notes:

All ratings are specified for T_j=25 °C unless otherwise stated.

(1) All voltage ratings are specified for an applied 50Hz/60Hz sinusoidal waveform over the temperature range 0 to +125 °C

(2) 10 msec. Max. Pulse width

(3) Maximum value for T_j=125 °C.

(4) Minimum value for linear and exponential waveshape to 67% rated V_{DRM}. Gate open, T_j=125 °C

(5) The value of di/dt is established in accordance with JB/T4193-2013.

Conducting-On State

Parameter	Symbol	Min.	Max.	Typ.	Units	Conditions
Average value of on-state current	I _{T(AV)}		1800		A	Sinewave, 180° conduction, T _c =55°C
RMS value of on-state current	I _{T(RMS)}		2826		A	Nominal value
Peak one cycle surge (non repetitive) current	I _{TSM}		25200		A	10 msec (50Hz), sinusoidal waveshape, 180° conduction, T _j = 125 °C
I square t	I ² t		3.2x10 ⁶		A ² s	10 msec
Latching current	I _L		1000		mA	V _D =12V; R _L =12ohms
Holding current	I _H		200		mA	V _D =12V; I=2.5A
Peak on-state voltage	V _{TM}		1.80		V	I _{TM} = 3000A; T _j =25°C
Threshold voltage, low-level	V _{TO}		1.38		V	T _j =125°C
Slope resistance, low-level	r _T		0.14		mΩ	1500 A to 3000A
Critical rate of rise of on-state current(5)	di/dt		200		A/μs	Repetition

Gating

Parameter	Symbol	Min.	Max.	Typ.	Units	Conditions
Peak gate power dissipation	P_{GM}		20		W	
Average gate power dissipation	$P_{G(AV)}$		4		W	
Gate trigger current	I_{GT}		200	150	mA	$V_D=12V; R_L=30\Omega; T_j=+25^\circ C$
Gate trigger voltage	V_{GT}	0.70	3.0	2.5	V	$V_D=12V; R_L=30\Omega; T_j=+25^\circ C$
Peak negative voltage	V_{GRM}		5		V	

Dynamic

Parameter	Symbol	Min.	Max.	Typ.	Units	Conditions
Delay time	t_d		3.0	2.5	μs	$I_{TM}=50A; V_D=67\%V_{DRM}$ Gate pulse: $V_G=30V; R_G=10\Omega$; $t_r=0.1\mu s; t_p=20\mu s$
Turn-off time ($V_R=-5V$)	t_q		20		μs	$I_{TM}=1800A; di/dt=-10A/\mu s$; $V_R=50V; dV/dt=30V/\mu s$; $V_D=67\%V_{DRM}; T_j=125^\circ C$
Reverse recovery current	Q_{rr}				μC	$I_{TM}=1800A; di/dt=-10A/\mu s$; $V_R=50V; T_j=125^\circ C$

THERMAL AND MECHANICAL CHARACTERISTICS AND RATINGS

Parameter	Symbol	Min.	Max.	Typ.	Units	Conditions
Operating temperature	T_j	-40	+125		$^\circ C$	
Storage temperature	T_{stg}	-40	+140		$^\circ C$	
Thermal resistance-junction to case	$R_{\theta(j-c)}$		0.016		$^\circ C/W$	Double sided cooled
Thermal resistance - case to heatsink	$R_{\theta(c-s)}$		0.005		$^\circ C/W$	Double sided cooled
Mounting force	P			30	kN	
Weight	W			0.72	kg.	

* Mounting surfaces smooth, flat and greased

