

N-Channel Enhancement Mode Field Effect Transistor

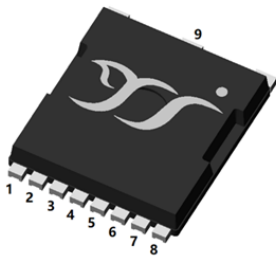

Top View

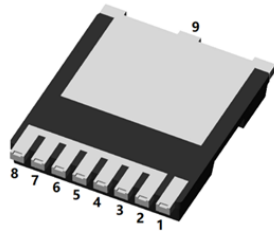

Bottom View

TOLL

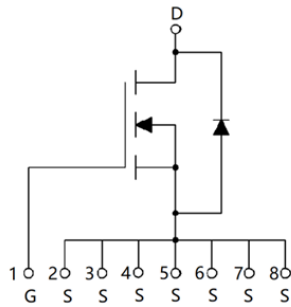

Product Summary

- V_{DS} 100V
- I_D 265A
- $R_{DS(ON)}$ (at $V_{GS}=10V$) $<2.1m\Omega$
- 100% EAS Tested
- 100% ∇V_{DS} Tested

General Description

- Split gate trench MOSFET technology
- Excellent package for heat dissipation
- High density cell design for low $R_{DS(ON)}$
- Moisture Sensitivity Level 1
- Epoxy Meets UL 94 V-0 Flammability Rating
- Halogen Free

Applications

- Load switch
- Battery management
- Solar

■ Absolute Maximum Ratings ($T_J=25^\circ C$ unless otherwise noted)

Parameter			Symbol	Limit	Unit
Drain-source Voltage			V_{DS}	100	V
Gate-source Voltage			V_{GS}	± 20	V
Continuous Drain Current (Note 1,2)	Steady-State	$T_A=25^\circ C$	I_D	25	A
		$T_A=100^\circ C$		17	
Continuous Drain Current (Note 1,3)	Steady-State	$T_C=25^\circ C$		265	
		$T_C=100^\circ C$		187	
Pulsed Drain Current	$T_C=25^\circ C, t_p=100\mu s$		I_{DM}	1060	A
Avalanche energy	$V_G=10V, R_G=25\Omega, L=2mH, I_{AS}=38.5A$		EAS	1482	mJ
Total Power Dissipation (Note 1,2)	Steady-State	$T_A=25^\circ C$	P_D	3.3	W
		$T_A=100^\circ C$		1.6	
Total Power Dissipation (Note 1,3)	Steady-State	$T_C=25^\circ C$		375	
		$T_C=100^\circ C$		187	
Junction and Storage Temperature Range			T_J, T_{STG}	-55~+175	$^\circ C$

■ Thermal resistance

Parameter		Symbol	Typ	Max	Units
Thermal Resistance Junction-to-Ambient (Note 2)	Steady-State	$R_{\theta JA}$	35	45	$^\circ C/W$
Thermal Resistance Junction-to-Case	Steady-State	$R_{\theta JC}$	0.3	0.4	

■ Ordering Information (Example)

PREFERRED P/N	PACKING CODE	Marking	MINIMUM PACKAGE(pcs)	INNER BOX QUANTITY(pcs)	OUTER CARTON QUANTITY(pcs)	DELIVERY MODE
YJT2D1G10H	F1	YJT2D1G10H	2000	4000	20000	13" reel



YJT2D1G10H

■ Electrical Characteristics (T_J=25°C unless otherwise noted)

Parameter	Symbol	Conditions	Min	Typ	Max	Units
Static Parameter						
Drain-Source Breakdown Voltage	BV _{DSS}	V _{GS} = 0V, I _D =250μA	100	-	-	V
		V _{GS} = 0V, I _D =1mA	100	-	-	V
Zero Gate Voltage Drain Current	I _{DSS}	V _{DS} =100V, V _{GS} =0V	-	-	1	μA
		V _{DS} =100V, V _{GS} =0V, T _J =125°C	-	-	100	
Gate-Body Leakage Current	I _{GSS}	V _{GS} = ±20V, V _{DS} =0V	-	-	±100	nA
Gate Threshold Voltage	V _{GS(th)}	V _{DS} = V _{GS} , I _D =250μA	2.2	3.0	3.8	V
Static Drain-Source On-Resistance	R _{DS(ON)}	V _{GS} =10V, I _D =50A	-	1.5	2.1	mΩ
Diode Forward Voltage	V _{SD}	I _S =30A, V _{GS} =0V	-	-	1.2	V
Gate resistance	R _G	f=1MHz	-	0.85	-	Ω
Maximum Body-Diode Continuous Current	I _S		-	-	265	A
Dynamic Parameters						
Input Capacitance	C _{iss}	V _{DS} =50V, V _{GS} =0V, f=1MHz	-	9600	-	pF
Output Capacitance	C _{oss}		-	3245	-	
Reverse Transfer Capacitance	C _{rss}		-	48	-	
Switching Parameters						
Total Gate Charge	Q _g	V _{GS} =10V, V _{DS} =50V, I _D =50A	-	132.5	-	nC
Gate-Source Charge	Q _{gs}		-	55	-	
Gate-Drain Charge	Q _{gd}		-	17	-	
Reverse Recovery Charge	Q _{rr}	I _F =50A, di/dt=100A/us	-	157	-	nC
Reverse Recovery Time	t _{rr}		-	93	-	ns
Turn-on Delay Time	t _{D(on)}	V _{GS} =10V, V _{DD} =50V, I _D =50A R _{GEN} =3Ω	-	30	-	ns
Turn-on Rise Time	t _r		-	48	-	
Turn-off Delay Time	t _{D(off)}		-	59	-	
Turn-off fall Time	t _f		-	34	-	

Note:

- The entire application environment impacts the thermal resistance values shown, they are not constants and are only valid for the particular conditions noted.
- The value of R_{θJA} is measured with the device mounted on the 40mm*40mm*1.1mm single layer FR-4 PCB board with 1 in² pad of 2oz. Copper, in the still air environment with T_A =25°C. The maximum allowed junction temperature of 175°C. The value in any given application depends on the user's specific board design.
- Thermal resistance from junction to soldering point (on the exposed drain pad).



YJT2D1G10H

Typical Electrical and Thermal Characteristics Diagrams

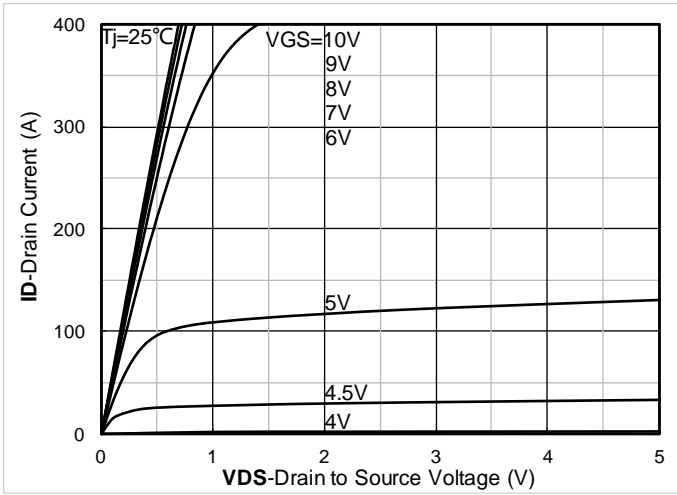

Figure 1. Output Characteristics

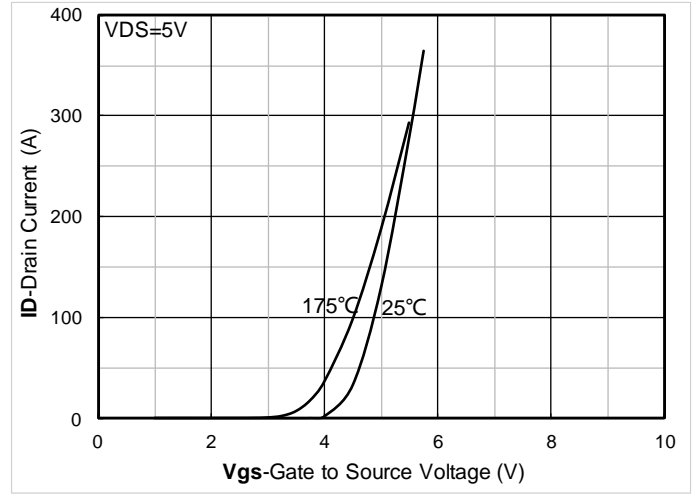

Figure 2. Transfer Characteristics

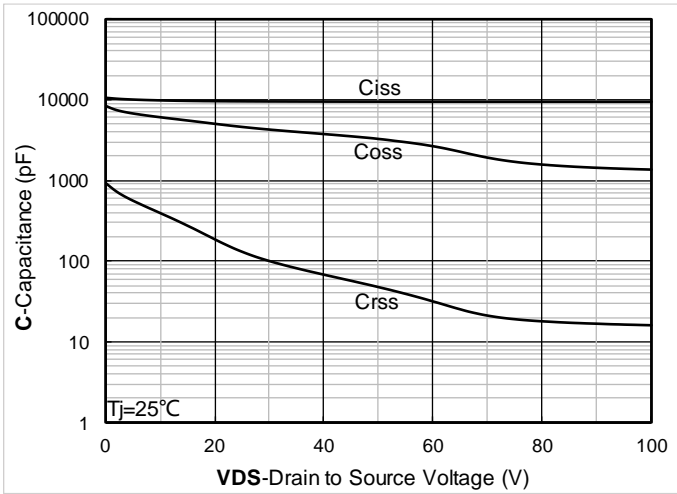

Figure 3. Capacitance Characteristics

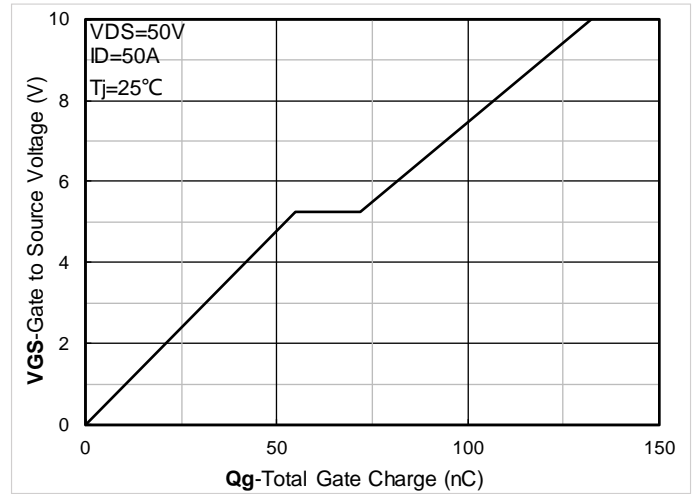

Figure 4. Gate Charge

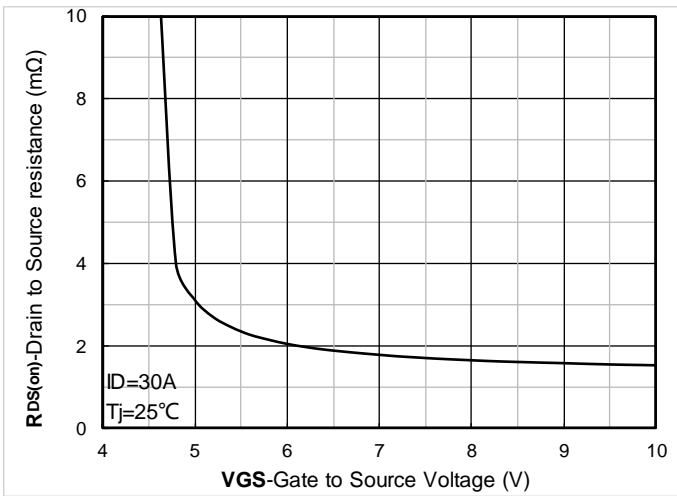

Figure 5. On-Resistance vs Gate to Source Voltage

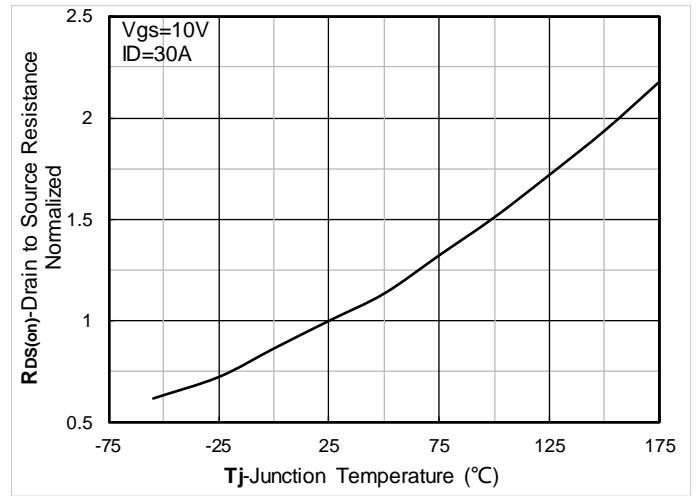

Figure 6. Normalized On-Resistance



YJT2D1G10H

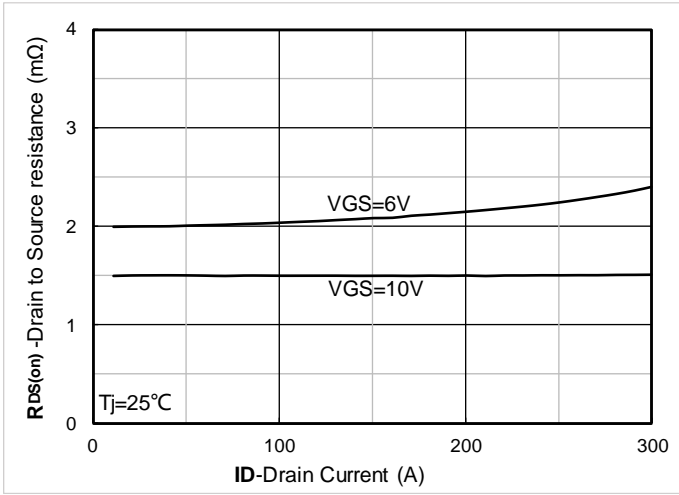

Figure 7. $R_{DS(on)}$ VS Drain Current

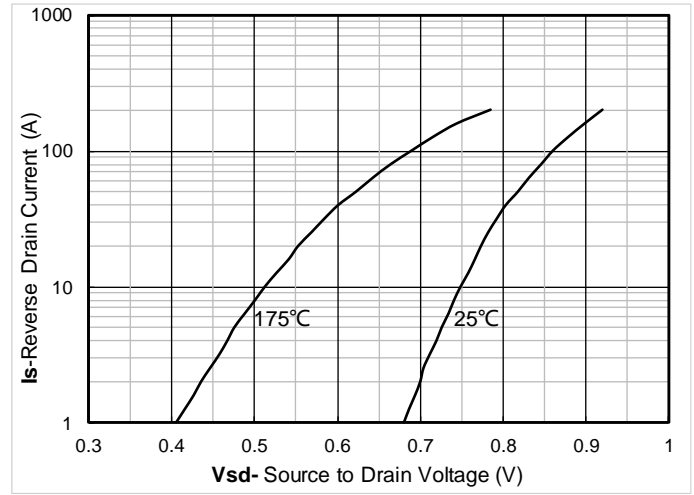

Figure 8. Forward characteristics of reverse diode

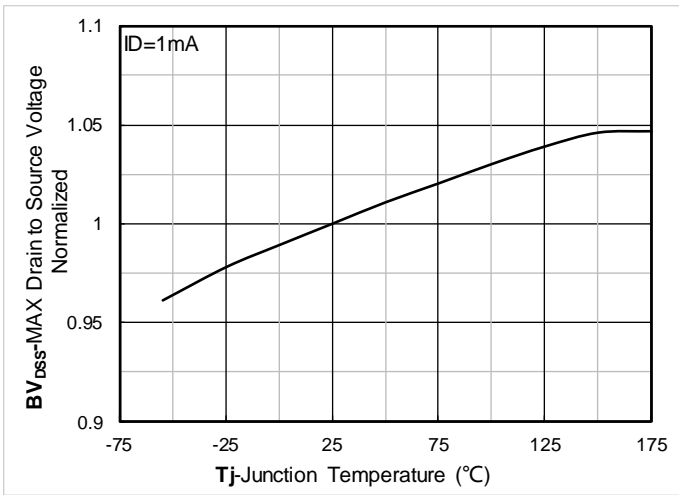

Figure 9. Normalized breakdown voltage

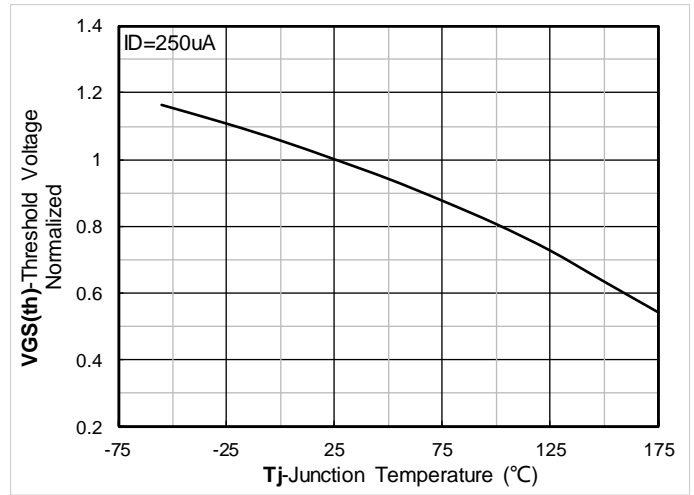

Figure 10. Normalized Threshold voltage

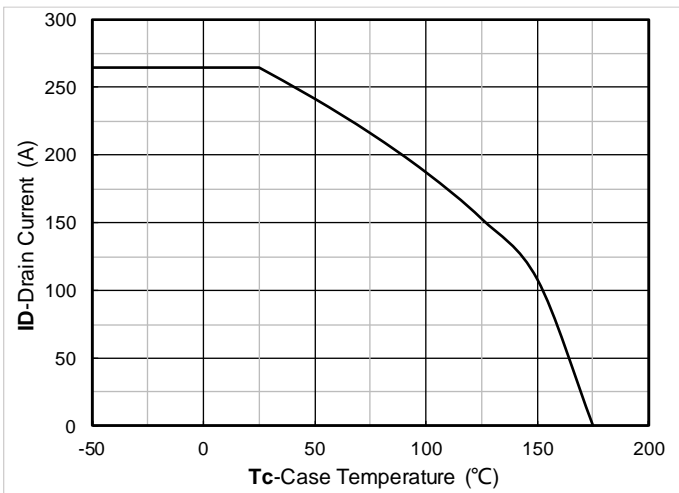

Figure 11. Current dissipation

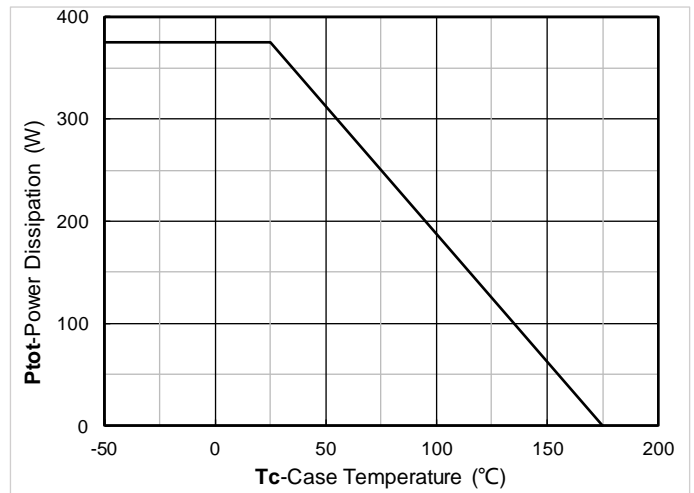

Figure 12. Power dissipation

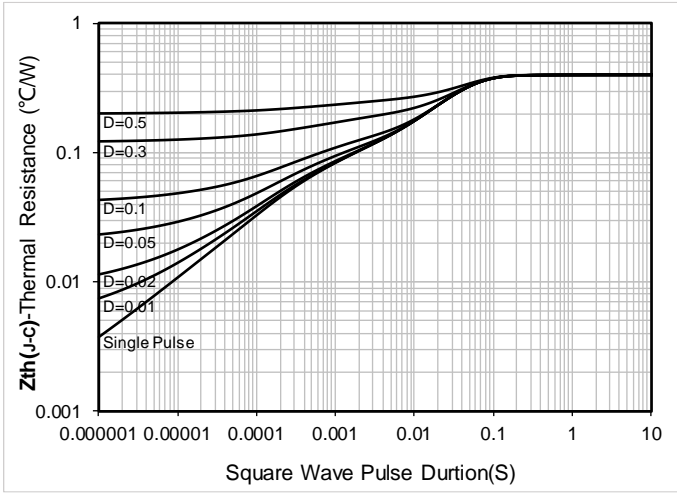

Figure 13. Maximum Transient Thermal Impedance

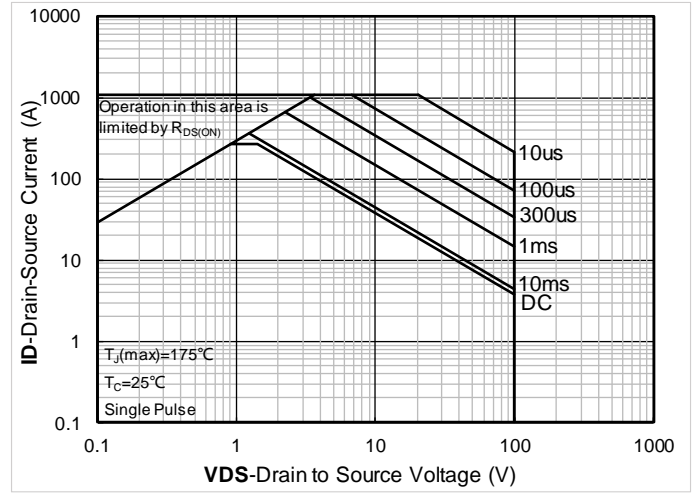

Figure 14. Safe Operation Area

■ Test Circuits & Waveforms

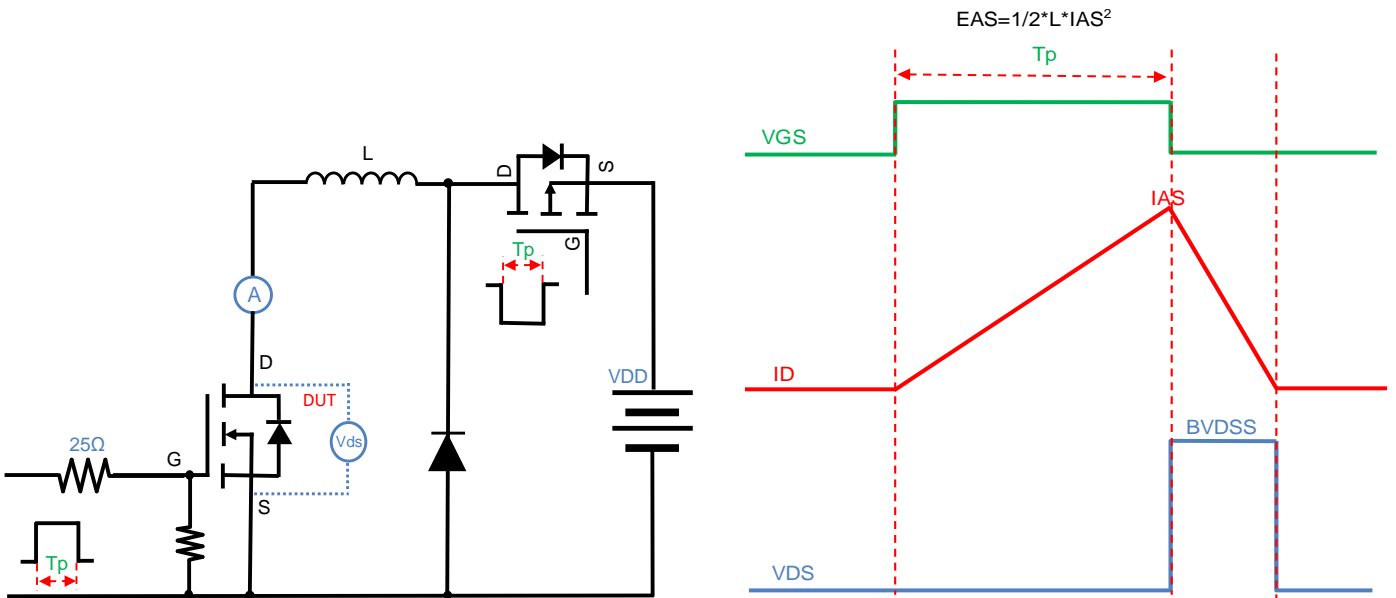

Figure A. Unclamped Inductive Switching (UIS) Test Circuit & Waveform

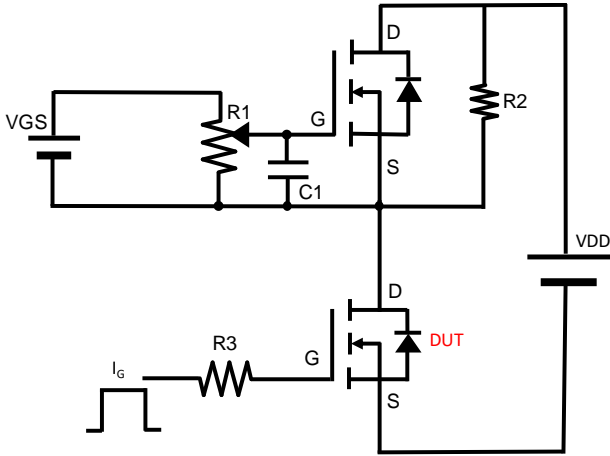

Figure B. Gate Charge Test Circuit & Waveform

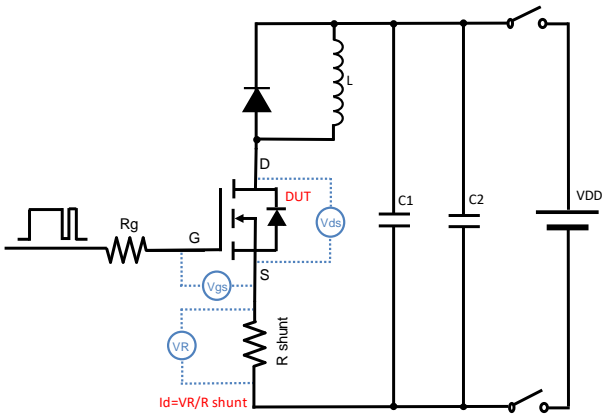

Figure C. Resistive Switching Test Circuit & Waveform

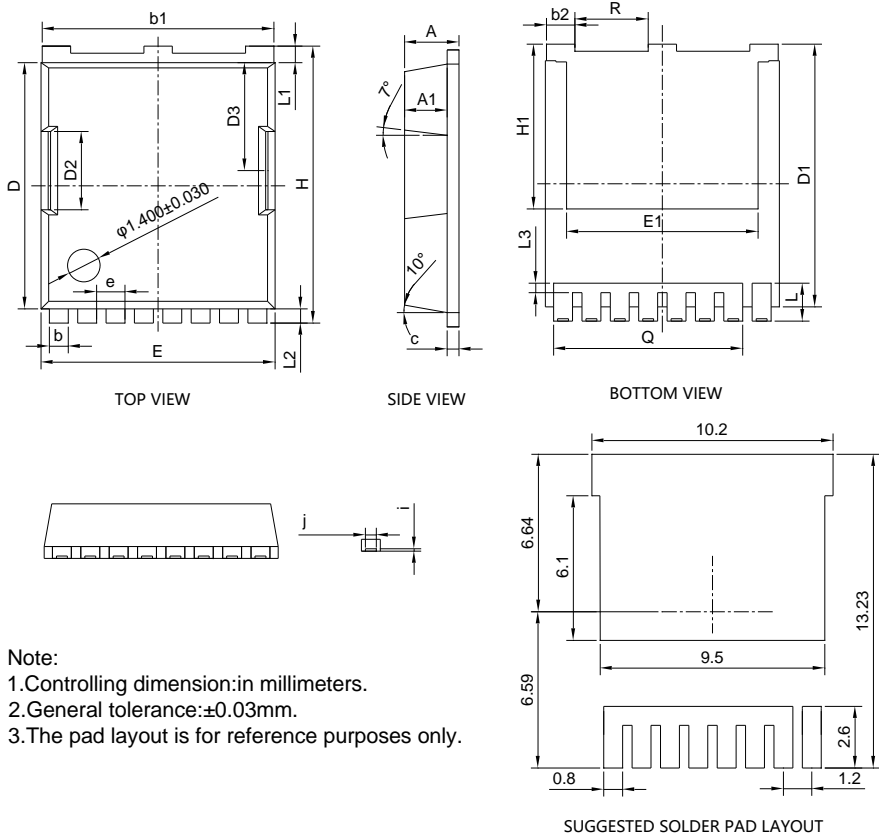

Figure D. Diode Recovery Test Circuit & Waveform



YJT2D1G10H

■ TOLL Package information



SYMBOL	MILLIMETER		
	MIN	NOM	MAX
A	2.2	2.3	2.4
A1	1.7	1.8	1.9
b	0.7	0.8	0.9
b1	9.7	9.8	9.9
b2	1.1	1.2	1.3
c	0.4	0.5	0.6
D	10.28	10.38	10.48
D1	10.98	11.08	11.18
D2	3.2	3.3	3.4
D3	4.45	4.55	4.65
E	9.8	9.9	10
E1	8	8.1	8.2
e	1.2 BSC		
H	11.58	11.68	11.78
H1	6.95 BSC		
i	0.1 REF		
j	0.46 REF		
L	1.5	1.6	1.7
L1	0.6	0.7	0.8
L2	0.5	0.6	0.7
L3	0.3	0.4	0.5
Q	8 REF		
R	3.0	3.1	3.2

Note:
 1. Controlling dimension: in millimeters.
 2. General tolerance: $\pm 0.03\text{mm}$.
 3. The pad layout is for reference purposes only.

UNIT: mm



YJT2D1G10H

Disclaimer

The information presented in this document is for reference only. Yangzhou Yangjie Electronic Technology Co., Ltd. reserves the right to make changes without notice for the specification of the products displayed herein to improve reliability, function or design or otherwise.

The product listed herein is designed to be used with automotive electronics, are not designed for use in medical, life-saving, lifesustaining, or military, Yangjie or anyone on its behalf, assumes no responsibility or liability for any damages resulting from such improper use of sale.

This publication supersedes & replaces all information previously supplied. For additional information, please visit our website <http://www.21yangjie.com> , or consult your nearest Yangjie's sales office for further assistance.