

Dual NPN+PNP Small Signal Transistor

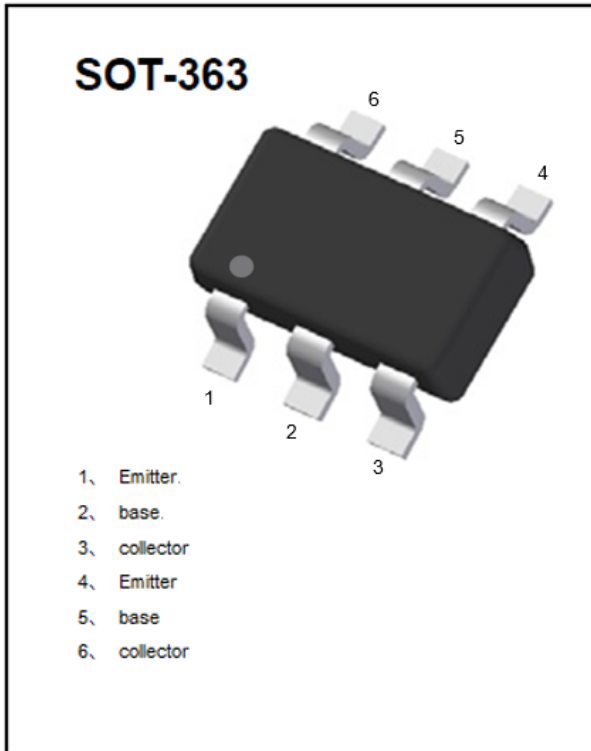

Features

- Epoxy meets UL-94 V-0 flammability rating
- Surface mount package ideally Suited for Automatic Insertion
- Reduces number of components and board space
- No mutual interference between the transistors
- Part no. with suffix "HQ" means AEC-Q101 qualified

Application

- General purpose Switching and amplification

Mechanical Data

- **Package:** SOT-363
- **Terminals:** Tin plated leads, solderable per J-STD-002 and JESD22-B102

Equivalent circuit

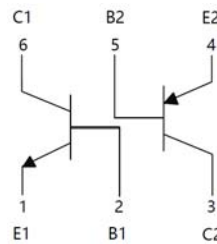

■TR1 NPN Pin1、 2、 6 Maximum Ratings (Ta=25°C Unless otherwise specified)

Item	Symbol	Unit	Value
Collector-Base Voltage	V_{CBO}	V	50
Collector-Emitter Voltage	V_{CEO}	V	45
Emitter-Base Voltage	V_{EBO}	V	6
Collector Current	I_C	mA	100
Collector Power Dissipation	P_C	mW	200
Thermal Resistance Junction to Ambient (*)	R_{thJA}	K/W	625
Junction Temperature	T_J	°C	-55 to +150
Storage Temperature	T_{stg}	°C	-55 to +150

(*) Device mounted on FR-4 PCB 1.0 x 1.0 x 0.06 inch



BC847PNHQ

■TR1 NPN Pin1、 2、 6 Electrical Characteristics (Ta=25°C unless otherwise specified)

Item	Symbol	Unit	Conditions	Min	TYP	Max
Collector-base breakdown voltage	V_{CBO}	V	$I_C=10\mu A, I_E=0$	50		
Collector-emitter breakdown voltage	V_{CEO}	V	$I_C=10mA, I_B=0$	45		
Emitter-base breakdown voltage	V_{EBO}	V	$I_E=10\mu A, I_C=0$	6		
Collector-Base cut-off current	I_{CBO}	nA	$V_{CB}=30V, I_E=0$			100
Emitter-Base Cut-off current	I_{EBO}	nA	$V_{EB}=5V, I_C=0$			100
DC current gain	h_{FE}		$V_{CE}=5V, I_C=2mA$	200		450
Collector-emitter saturation voltage	$V_{CE(sat)}$	V	$I_C=10mA, I_B=0.5mA$			0.25
			$I_C=100mA, I_B=5mA$			0.65
Baser-emitter saturation voltage	$V_{BE(sat)}$	V	$I_C=10mA, I_B=0.5mA$			1.05
			$I_C=100mA, I_B=5mA$			1.1
Base-emitter Voltage	V_{BE}	V	$V_{CE}=5V, I_C=2mA$	0.58		0.7
Transition frequency	f_T	MHz	$V_{CE}=5V, I_C=10mA, f=100MHz$	100		

■TR2 PNP Pin3、 4、 5 Maximum Ratings (Ta=25°C Unless otherwise specified)

Item	Symbol	Unit	Value
Collector-Base Voltage	V_{CBO}	V	-50
Collector-Emitter Voltage	V_{CEO}	V	-45
Emitter-Base Voltage	V_{EBO}	V	-5
Collector Current	I_C	mA	-100
Power Dissipation (*)	P_D	mW	200
Thermal Resistance Junction to Ambient (*)	R_{thJA}	K/W	625
Junction Temperature	T_j	°C	-55 to +150
Storage Temperature	T_{stg}	°C	-55 to +150

(*) Device mounted on FR-4 PCB 1.0 x 1.0 x 0.06 inch



BC847PNHQ

■TR2 PNP Pin3、4、5 Electrical Characteristics (Ta=25°C unless otherwise specified)

Item	Symbol	Unit	Conditions	Min	TYP	Max
Collector-base breakdown voltage	V_{CBO}	V	$I_C=-10\mu A, I_E=0$	-50		
Collector-emitter breakdown voltage	V_{CEO}	V	$I_C=-10mA, I_B=0$	-45		
Emitter-base breakdown voltage	V_{EBO}	V	$I_E=-10\mu A, I_C=0$	-5		
Collector-Base cut-off current	I_{CBO}	nA	$V_{CB}=-30V, I_E=0$			-100
Emitter-Base Cut-off current	I_{EBO}	nA	$V_{EB}=-5V, I_C=0$			-100
DC current gain	h_{FE}		$V_{CE}=-5V, I_C=-2mA$	220		475
Collector-emitter saturation voltage	$V_{CE(sat)}$	V	$I_C=-10mA, I_B=-0.5mA$			-0.3
			$I_C=-100mA, I_B=-5mA$			-0.65
Baser-emitter saturation voltage	$V_{BE(sat)}$	V	$I_C=-10mA, I_B=-0.5mA$			-1
			$I_C=-100mA, I_B=-5mA$			-1.1
Base-emitter Voltage	V_{BE}	V	$V_{CE}=-5V, I_C=-2mA$	-0.6		-0.75
Transition frequency	f_T	MHz	$V_{CE}=-5V, I_C=-10mA, f=30MHz$	100		

■ Ordering Information (Example)

PREFERED P/N	PACKING CODE	UNIT WEIGHT(g)	MINIMUM PACKAGE(pcs)	INNER BOX QUANTITY(pcs)	OUTER CARTON QUANTITY(pcs)	DELIVERY MODE
BC847PNHQ	F2	Approximate 0.007g	3000	30000	120000	7" reel



■ TR1 NPN Pin1、2、6 Characteristics (Typical)

Fig.1-Static Characteristic

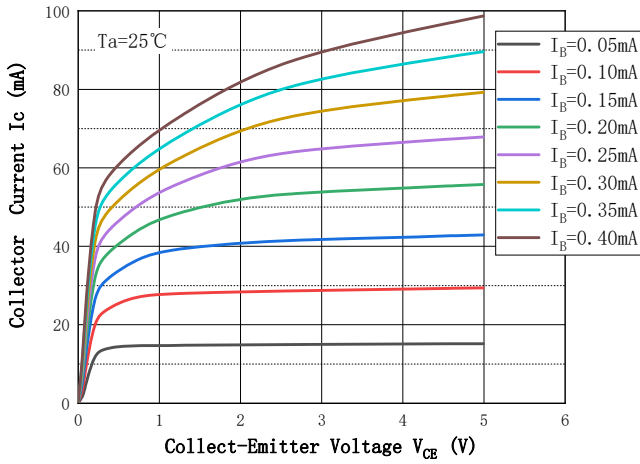

Fig.2 - DC Current Gain

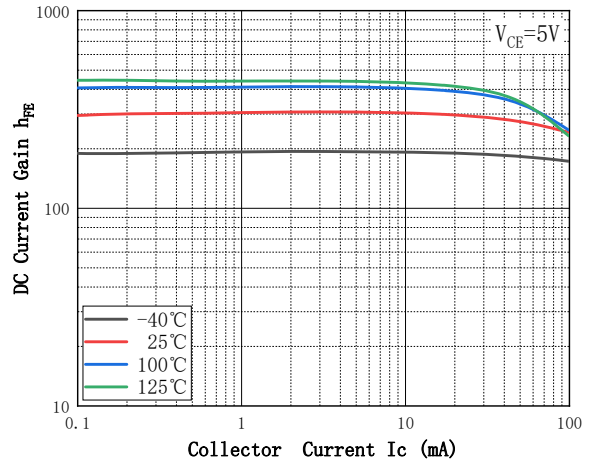

Fig.3 - Collect-Emitter Saturation Voltage

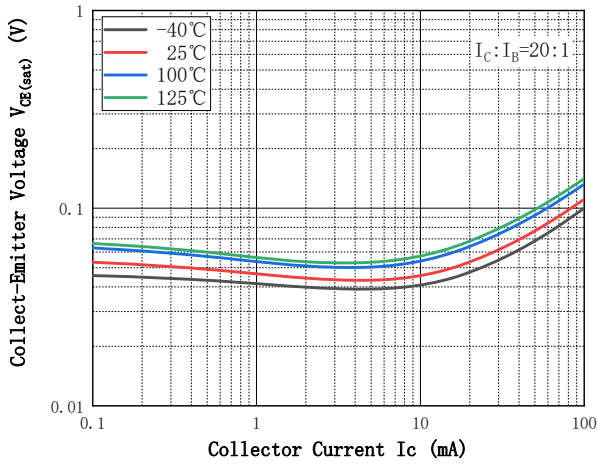

Fig.4 - Base-Emitter Voltage

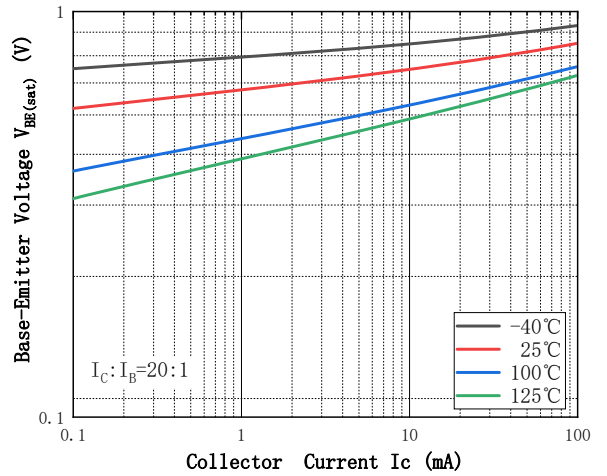

Fig.5 - Base-Emitter On Voltage

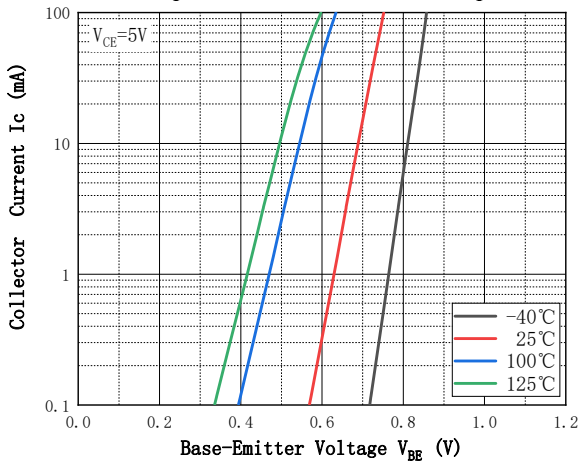
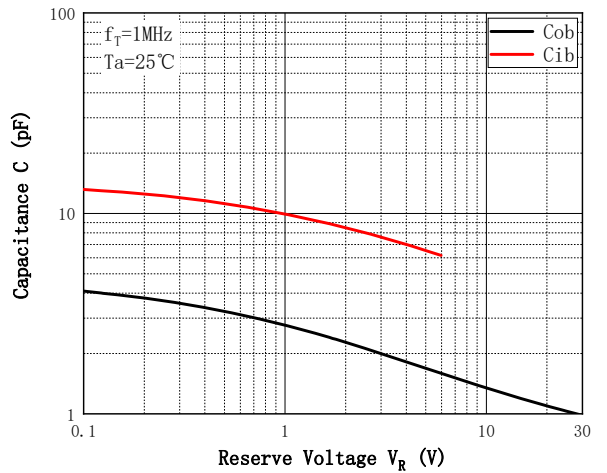

Fig.6 - Cob/Cib— V_{CB}/V_{EB}





■ TR2 PNP Pin3、4、5 Characteristics (Typical)

Fig.1-Static Characteristic

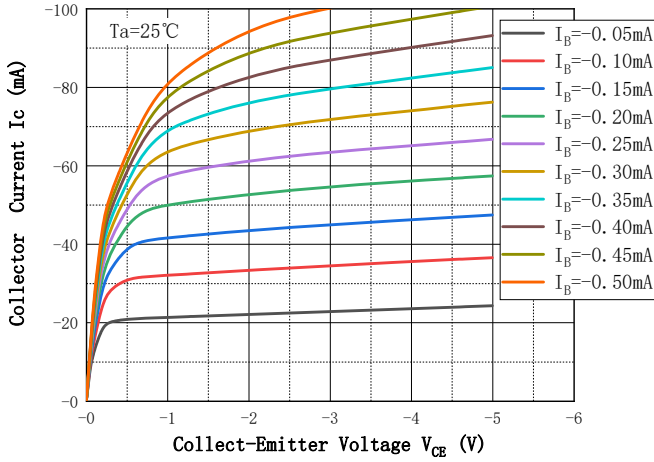

Fig.2 - DC Current Gian

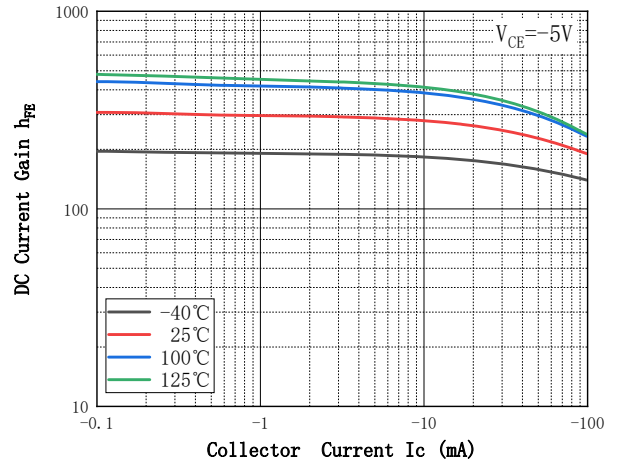

Fig.3 - Collect-Emittor Saturation Voltage

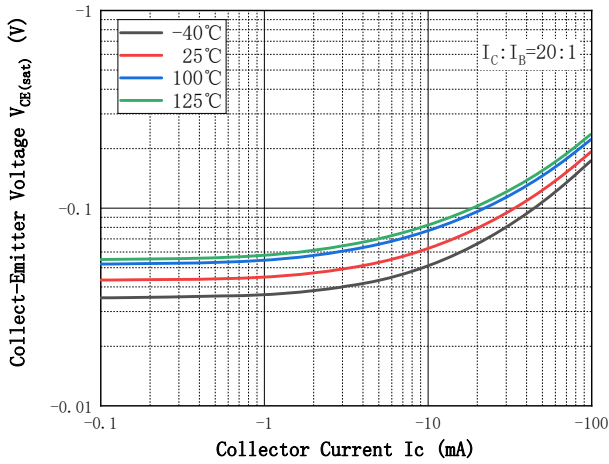

Fig.4 - Base-Emittor Voltage

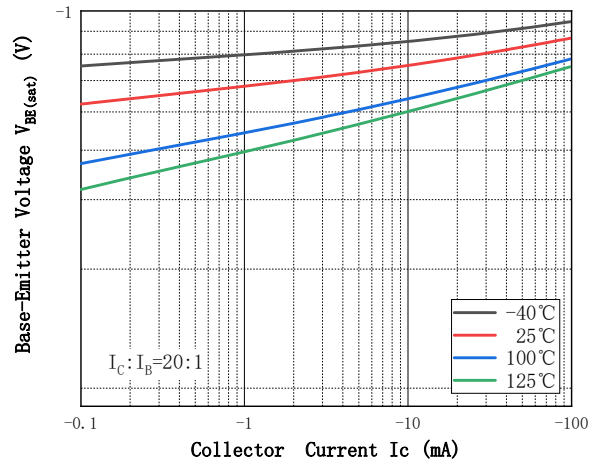

Fig.5 - Base-Emittor On Voltage

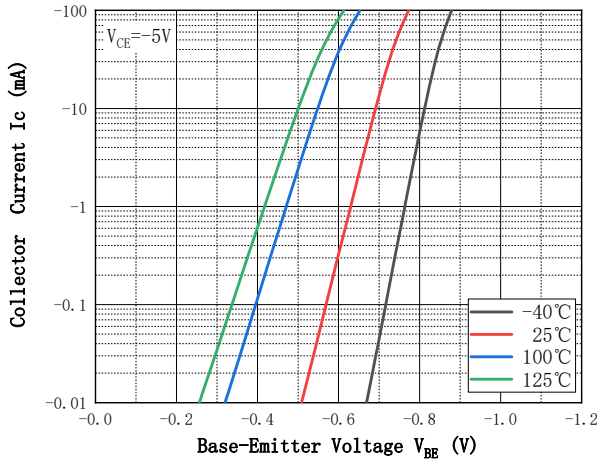
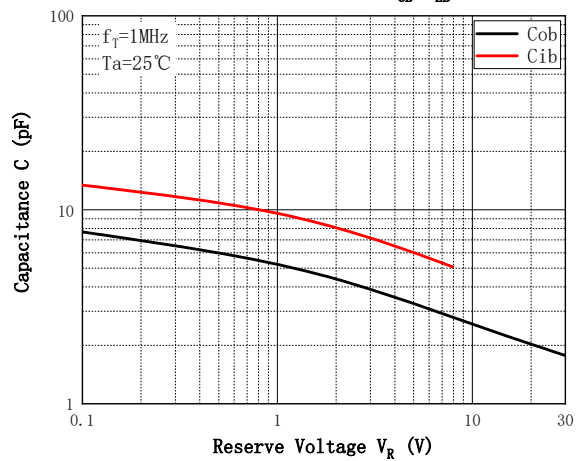

Fig.6 - Cob/Cib— V_{CE}/V_{EB}





BC847PNHQ

■ SOT-363 Package Outline Dimensions & Soldering Footprint

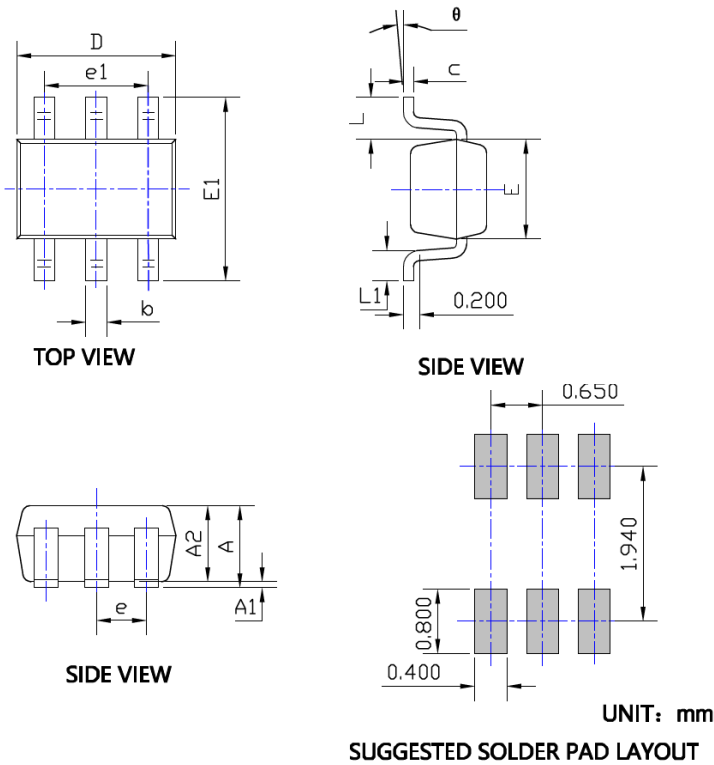

SYMBOL	DIMENSIONS			
	INCHES		Millimeter	
	MIN.	MAX.	MIN.	MAX.
A	0.035	0.043	0.900	1.100
A1	0.000	0.004	0.000	0.100
A2	0.035	0.039	0.900	1.000
b	0.006	0.014	0.150	0.350
c	0.004	0.010	0.100	0.250
D	0.071	0.087	1.800	2.200
E	0.045	0.053	1.150	1.350
E1	0.085	0.096	2.150	2.450
e	0.026TYP		0.650TYP	
e1	0.047	0.055	1.200	1.400
L	0.021REF		0.525REF	
L1	0.010	0.018	0.260	0.460
θ	0°	8°	0°	8°

NOTE:
 1. PACKAGE BODY SIZES EXCLUDE MOLD FLASH AND GATE BURRS.
 2. TOLERANCE 0.1mm UNLESS OTHERWISE SPECIFIED.
 3. THE PAD LAYOUT IS FOR REFERENCE PURPOSES ONLY.

■ Marking Information

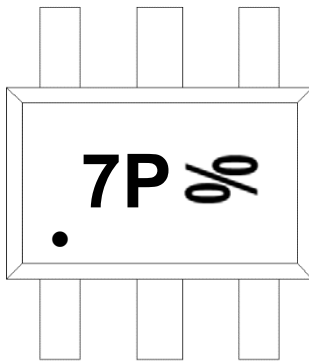

Note:

1. All marking is at middle of the product body
2. All marking is in laser marking
3. Body color: Black
4. 7P% is Marking Code (%=placeholder for date code)

*Date Code vary depending upon production date.



BC847PNHQ

Disclaimer

The information presented in this document is for reference only. Yangzhou Yangjie Electronic Technology Co., Ltd. reserves the right to make changes without notice for the specification of the products displayed herein to improve reliability, function or design or otherwise.

The product listed herein is designed to be used with automotive electronics, are not designed for use in medical, life-saving, lifesustaining, or military, Yangjie or anyone on its behalf, assumes no responsibility or liability for any damages resulting from such improper use of sale.

This publication supersedes & replaces all information previously supplied. For additional information, please visit our website [http:// www.21yangjie.com](http://www.21yangjie.com) , or consult your nearest Yangjie's sales office for further assistance.