



1200V SiC Power Module Dual Diode Pack

V_{DC}	1200V
I_F	2×40A
$T_{J,max}$	175°C

Applications

- Welding equipment
- Uninterruptible power supply (UPS)
- High frequency power supply
- Induction heating
- High speed rectifiers

Features

- SiC Schottky Diode
 - Zero reverse recovery
 - Zero forward recovery
 - Temperature independent switching behavior
 - Positive temperature coefficient on V_F
- Very low stray inductance
- Low forward voltage
- Isolated package (SOT-227)
- Low noise switching
- RoHS compliant

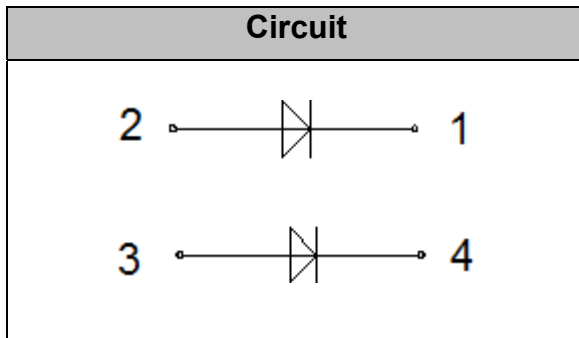

Absolute Maximum Ratings ($T_J=25^\circ\text{C}$ unless otherwise specified, per leg)

Parameter	Symbol	Test Conditions	Value	Unit
Peak Repetitive Reverse Voltage	V_{RRM}	$T_J=25^\circ\text{C}$	1200	V
DC Blocking Voltage	V_{DC}	$T_J=25^\circ\text{C}$	1200	V
Continuous Forward Current	I_F	$T_C=25^\circ\text{C}, T_J=175^\circ\text{C}$	82	A
		$T_C=131^\circ\text{C}, T_J=175^\circ\text{C}$	40	
		$T_C=135^\circ\text{C}, T_J=175^\circ\text{C}$	37	
Non-Repetitive Peak Forward Surge Current	I_{FSM}	$T_C=25^\circ\text{C}, T_P=10\text{ms}, \text{Half Sine Wave}$	306	A
I^2t Value	$\int I^2 dt$	$T_C=25^\circ\text{C}, T_P=10\text{ms}$	468	A^2s
Power Dissipation	P_{Tot}	$T_C=25^\circ\text{C}$	267	W
Junction Temperature	T_J		-55...175	$^\circ\text{C}$
Storage Temperature	T_{STG}		-55...175	$^\circ\text{C}$



Electrical Characteristics ($T_J=25^\circ\text{C}$ unless otherwise specified, per leg)

Parameter	Symbol	Test Conditions	Value			Unit
			Min.	Typ.	Max.	
Reverse Current	I_R	$V_R=1200\text{V}, T_J=25^\circ\text{C}$	--	7.1	100	μA
		$V_R=1200\text{V}, T_J=175^\circ\text{C}$	--	38	--	
Forward Voltage	V_F	$I_F=40\text{A}, T_J=25^\circ\text{C}$	--	1.36	1.7	V
		$I_F=40\text{A}, T_J=175^\circ\text{C}$	--	1.94	--	
Total Capacitance	C	$V_R=0\text{V}, f=1\text{MHz}$	--	2966	--	pF
		$V_R=400\text{V}, f=1\text{MHz}$	--	212	--	
		$V_R=800\text{V}, f=1\text{MHz}$	--	164	--	
Total Capacitive Charge	Q_C	$V_R=800\text{V}$	--	224	--	nC
Capacitance Stored Energy	E_C	$V_R=800\text{V}$	--	57	--	μJ

Thermal and Package Characteristics ($T_J=25^\circ\text{C}$ unless otherwise specified)

Parameter	Symbol	Test Conditions	Value	Unit
Thermal Resistance, Junction to Case	R_{thJC}	Per leg	0.56	$^\circ\text{C}/\text{W}$
Isolation Breakdown Voltage	V_{isol}	AC, 50Hz (R.M.S), T=3s	3600	V
Mounting Torque	M	Recommended (M4 screw)	1~1.5	Nm
Terminal Connection Torque		Recommended (M4 screw)	1~1.5	
Weight	W		29	g

Typical Performance Per Leg

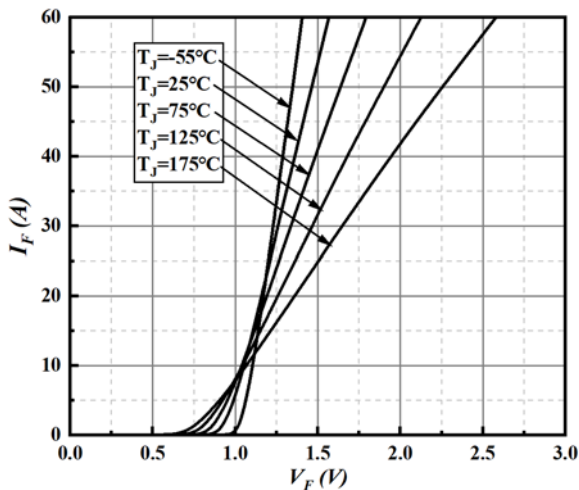

Fig1. Forward Characteristics (parameterized on T_J)

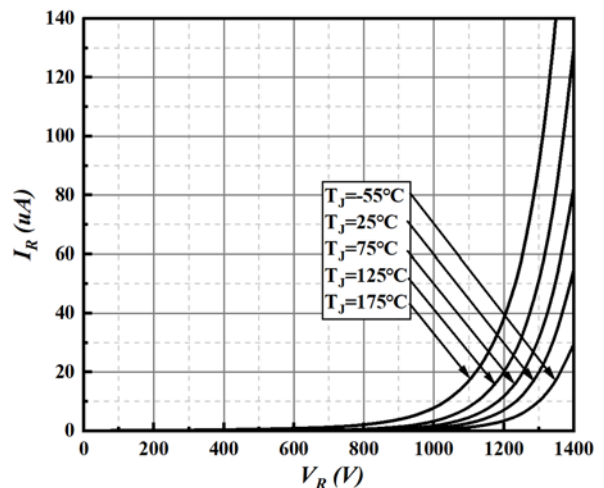

Fig2. Reverse Characteristics (parameterized on T_J)

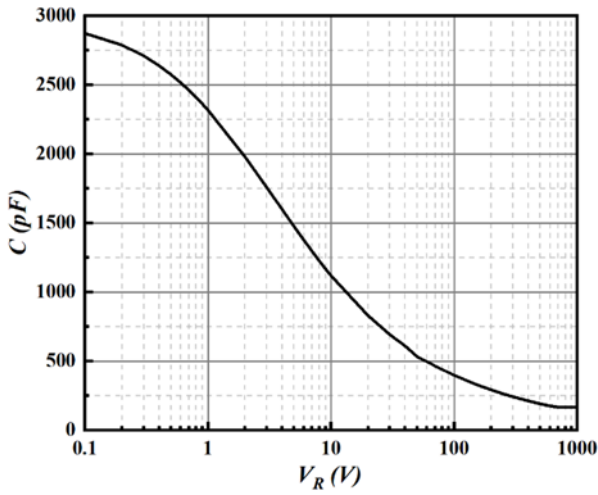

Fig3. Total Capacitance

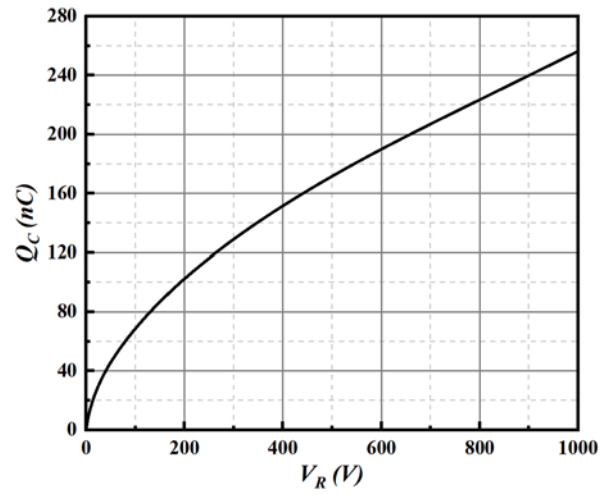

Fig4. Total Capacitive Charge

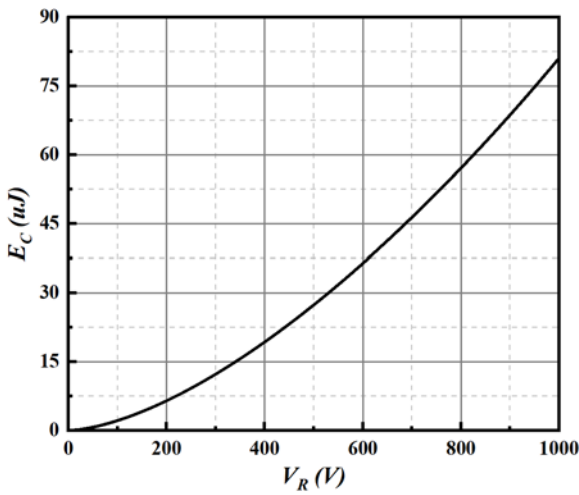

Fig5. Capacitance Stored Energy

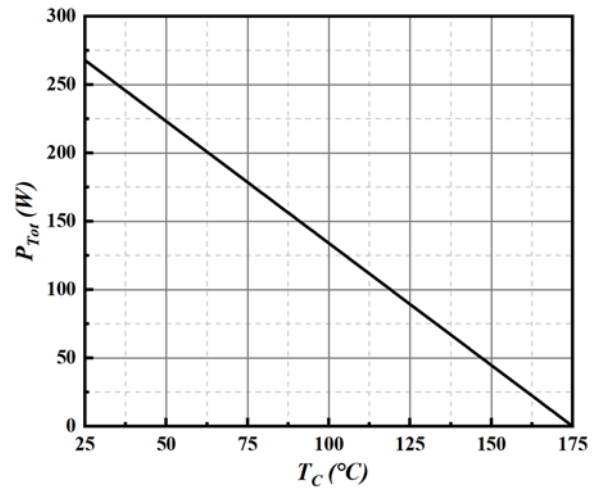

Fig6. Power Derating

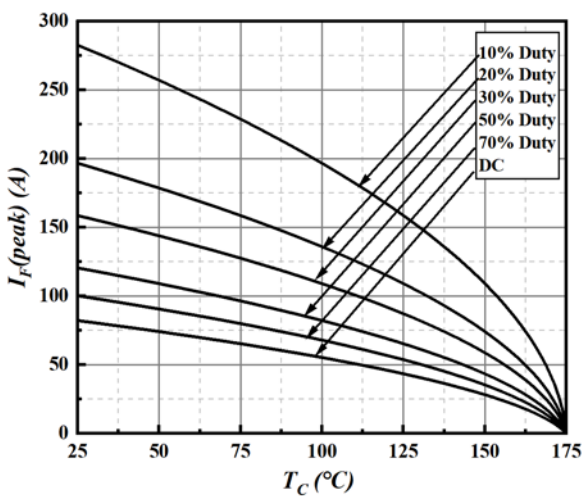

Fig7. Current Derating

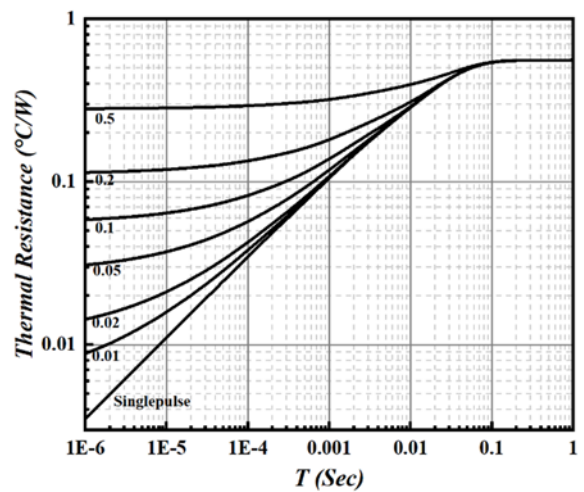
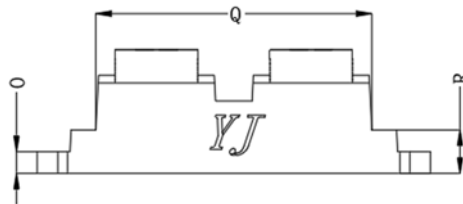
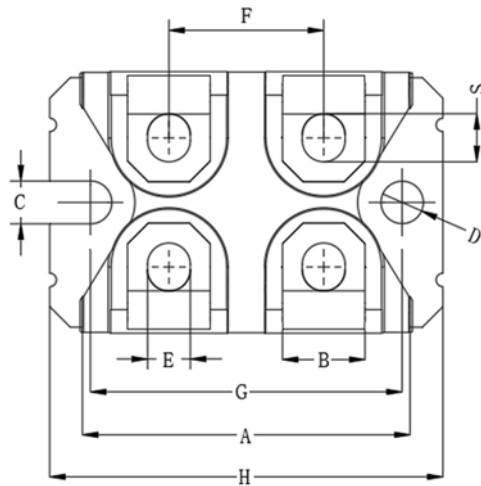
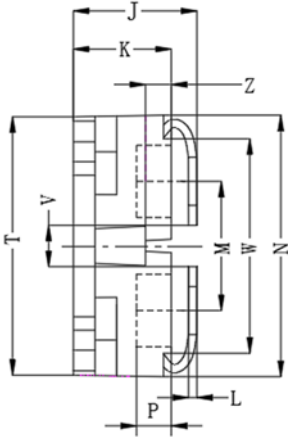

Fig8. Transient Thermal Impedance

Package Outline Information

CASE: ST



DIM	Millimeter	
	min	max
A	31.60	31.80
B	7.70	8.10
C	4.20	4.40
D	4.20	4.40
E	4.10	4.40
F	14.90	15.10
G	30.10	30.30
H	37.70	38.20
J	12.00	12.60
K	9.35	9.65
L	0.74	0.84
M	12.40	12.80
N	24.80	25.60
O	1.90	2.10
P	2.92	3.32
Q	26.60	27.00
R	3.80	4.20
S	4.95	5.45
T	23.70	24.30
V	3.50	5.50
W	20.55	20.85
Z	2.50	2.70

Dimensions in mm



Disclaimer

The information presented in this document is for reference only. Yangzhou Yangjie Electronic Technology Co., Ltd. reserves the right to make changes without notice for the specification of the products displayed herein to improve reliability, function or design or otherwise.

The product listed herein is designed to be used with ordinary electronic equipment or devices, and not designed to be used with equipment or devices which require high level of reliability and the malfunction of which would directly endanger human life (such as aerospace machinery, nuclear-reactor controllers, fuel controllers and other safety devices), Yangjie or anyone on its behalf, assumes no responsibility or liability for any damages resulting from such improper use of sale.

This publication supersedes & replaces all information previously supplied. For additional information, please visit our website [http:// www.21yangjie.com](http://www.21yangjie.com) , or consult your nearest Yangjie's sales office for further assistance.